

OPERATING INSTRUCTIONS

VHF Ground Station TG 560 - ()

Becker Flugfunkwerk GmbH
Baden Airpark
77836 Rheinmünster
Germany

Tel. +49 (0) 7229 / 305-0
Fax +49 (0) 7229 / 305-217
<http://www.becker-avionics.com>
Email : info@becker-avionics.de



Subject to technical changes

© Copyright bei / by Becker Flugfunkwerk

Repair instructions

If an equipment fault the unit may be sent to a Becker Dealer or the Becker customer service together with a description of the fault. The completed fault description shortens the repair times and hence lowers the resultant costs.

These operating instructions do not replace the equipment manuals listed below.

Equipment manuals

to be purchased from the manufacturer or Becker Dealer :

Installation and Operation DV 68410.03

Article no.: 0578.711-071

Maintenance and Repair DV 68410.04

Article no.: 0578.703-071

Table of contents

	Page
Important	5
Introduction	5
Safety information	6
<input type="checkbox"/> Additional information	7
General information	9
Controls and indicator	10
<input type="checkbox"/> Function of controls and indicators	11
<input type="checkbox"/> LCD (liquid crystal display) elements	12
<input type="checkbox"/> Standard mode	12
<input type="checkbox"/> Channel mode	13
<input type="checkbox"/> Display dimming	14
<input type="checkbox"/> Service mode	14
<input type="checkbox"/> Connecting sockets rear side	15
<input type="checkbox"/> Operating instructions	16
<input type="checkbox"/> Switching on the VHF ground station	16
<input type="checkbox"/> Power on Built in Test (PBIT)	16
<input type="checkbox"/> Operation of the standard mode	19
<input type="checkbox"/> Setting operating frequency	20
<input type="checkbox"/> Storage procedure	21
<input type="checkbox"/> Channel mode	23
<input type="checkbox"/> Test IBIT	23
<input type="checkbox"/> CBIT functions	25
<input type="checkbox"/> Display dimming	26
<input type="checkbox"/> Service mode	27
<input type="checkbox"/> Transmit/Receive mode of the station-	29
<input type="checkbox"/> Safety instructions	30
<input type="checkbox"/> Technical data	32

	Page
<input type="checkbox"/> Repair instructions	34
<input type="checkbox"/> Equipment manuals	34

AF- line output level	-20 dBm to 10 dBm adjustable with internal potentiometer
Transmitter data	
Transmitter output power	$\geq 20 \text{ W}$
Frequency stability	$\leq 1 \text{ ppm}$
Modulation type	AM; A3EJN
Modulation factor	$85\% \leq m \leq 90\%$
Distortion	$\leq 10\%$
AF- line input level	- 20 dBm to 10 dBm, adjustable with internal potentiometer
Dynamic mike sensitivity	2 mV to 10 mV @ 200 Ω balanced
Standard mike sensitivity	75 mV 250 mV @ 150 Ω unbalanced DC supply 12 V/470 Ω
AF- line input impedance	600 $\Omega \pm 10\%$

Technical data

AC operating voltage	115 V or 230 V AC 50/60 Hz
DC operating voltage	24 V nominal
Operating temperature range	- 20° C . . . + 55° C
Dimensions (W x D x H)	483 x 350 x 89 mm
Weight	7.7 kg
Frequency range	118.000 MHz . . . 136.975 MHz
Extended frequency version	118.000 MHz155.975 MHz
Channel spacing	25 kHz / 8.33 kHz
Number of channel memories	20

Receiver data

Sensitivity	$\leq 101\text{dBm}$ for 12 dB SINAD
Bandwidth	$\geq \pm 2.8$ kHz for 8.33 kHz $\geq \pm 8.5$ kHz for 25 kHz
Squelch operation	$6\text{ dB} \leq \frac{(S+N)}{N} \leq 12\text{dB}$ software adjustable
Override level	≤ -85 dBm
Hysteresis	≤ 6 dB
Audio noise	≥ 40 dB (S+N)/N @ -13 dBm
AF output power	
- at speaker mode	typ. 2W into 4 Ω
- at headphone mode	typ. 100mW into 600 Ω unbalanced adjustable with volume control

Important

Carefully read these operating instructions right through before attempting to operate the VHF Ground Station.

Keep these operating instructions carefully. They contain important safety and operating instructions for the VHF Ground Station.

Introduction

Thank you for purchasing the BECKER VHF Ground Station. The VHF Ground Station is easy to operate. The technology used state of the art.

To fully utilise the capabilities of your VHF Ground Station, please carefully read these operating instructions before you starting operating the set.

If you have any questions regarding the operation of the VHF Ground Station, please get in touch with your nearest becker dealer or with the becker product support.

The CAUTION, WARNING and NOTE highlights have the following meanings:

WARNING	Failure to comply, or incorrect compliance, with these instructions or procedures can lead to injuries or fatal accidents.
CAUTION	Failure to comply, or incorrect compliance, with these instructions or procedures can lead to damage to equipment.
NOTE	Feature to which attention should be drawn.

Safety information

WARNING

- The unit may be only opened by qualified personnel (High voltage !)
- Disconnect power input before servicing.

CAUTION

- Never connect the VHF Ground Station with reversed polarity to an external DC voltage.
- The installation or use of the VHF Ground Station in ambient temperatures below - 15° C or above + 50° C is to be avoided.
- The internal fuses may be replaced only by fuses of the specified value.

- Use only microphones or headsets which are suitable for use in aircraft. Incoming radiation on the equipment antenna can affect the integrated amplifier of the microphone (feedback). This is noticeable in the station by whistling and/or heavy distortion. The described disturbances can occur in different ways on the different transmission channels.
- Transmit buttons can stick and cause continuous transmission. Therefore, when transmitting ensure that the display (ON AIR) disappears when the transmission button is released.

WARNNIG

- High voltages inside. Refer servicing to qualified personnel
- Disconnect mains cable before opening the cover.

Operate the transmit key and call the corresponding station. Hold the microphone close to your lips for optimum speech transmission.

NOTE

The transmit mode appears in the upper right part of the display "ON AIR". During transmission a protective circuit prevents a frequency change or frequency channel change or mode change.

Using the VOL volume control set the correct reception volume whilst the called station is answering. The external and internal speaker can be switched on or off with the LSP key on the front panel.

Switch on the squelch (press SQL key). "SQL ON" indication appears in the right middle part of the display. Weak reception signals and reception noise are suppressed. The squelch threshold can be set in the service mode.

Safety instructions

The following instructions must be followed for safe operation of the station:

- A speech test is to be performed before startup and it should be noted that if the speech test is carried out close to the station the results may be positive even if the antenna cable is broken or short-circuited. At a distance of 5 to 10 km no connection will be made.
- Use a loud voice for speech communication and hold the microphone close to the lips. Otherwise ambient noise can be intrusive and make understanding difficult.

Additional information

- A speech test is to be performed before startup and it should be noted that if the speech test is carried out close to the ground station the results may be positive even if the antenna cable is broken or short-circuited. At a distance of 5 to 10 km no connection will be made.
- Use a loud voice for speech communication and hold the microphone close to the lips. Otherwise noise can be intrusive and make understanding difficult.
- Use only microphones or headsets which are suitable for use in aircraft. Incoming radiation on the equipment antenna can affect the integrated amplifier of the microphone (feedback). This is noticeable in the ground station by whistling and/or heavy distortion. The described disturbances can occur in different ways on the different transmission channels.
- Transmit buttons can stick and cause continuous transmission. Therefore, when transmitting ensure that the indication ON AIR disappears when the transmission button is released.

BLANK

- Read only operating timer,
- Read only life cycle data.
- Print out and/or save on disk:
 - Operator Name,
 - Actual date,
 - programmed channels,
 - Squelch level setting,
 - Error history,
 - Operating timer status,
 - Life cycle data,

Transmit/Receive mode of the station

Switch on the station using the ON/OFF STANDBY switch on the front plate. The "Becker Logo" appears for 2 seconds in the LC display

Note

The equipment works with AC-power as standard. If the AC-power fails, an automatic switch over to DC-power is performed. If AC-power becomes available again, automatic switch over back to AC-power is performed.

Depending on which power the station is operated, the associated indication at the front panel (LED green) is illuminated

If the station switches from AC to DC-power or vice-versa, the station is operable with the same functions and settings as previously.

The settings selected before switch off is automatically restored when the VHF ground station is switched on.

For interface data see following table1 (service connector)

Name	Technical data	Connector type / placement	Pin-name	Source	Destination
Remote-data port	Type: serial RS232 or RS422 standard 8 data bit, no parity bit 9600 baud	D-Sub, 9 pol / screw looking device rear-side	TX+(TXD) RX+(RXD) TX- RX- Shield	TG560	Test-PC
Service-data port	Type: serial RS232 standard 8 data bit, no parity bit 9600 baud	D-Sub, 9 pol / without looking device. Front panel	RXD TXD Shield	TG560	Service PC

The required software tool for the note-book PC is designed and developed. This software is operable with the following software platforms:

Windows 98, 2000, NT or XP version

Together with the connected PC and a special software tool, it is possible to readout, change and store functions parameters and unit data as follows:

- Input operator name
- Read and change channel programming,
- Read and change squelch level setting,
- Read only error history,

General information

The VHF ground station is a fixed ground station for voice communications in the VHF frequency range of 118.000 MHz to 136.975 Mhz with 25 kHz/ 8,33 kHz channel spacing in the standard version. In the extended frequency version it operates in the frequency range from 118.000 MHz to 155.975 MHz.

The VHF ground station is designed for airport and airfield use and can be used as a main transceiver on landing fields and as a standby unit on airports and for special tasks within the scope of air traffic control.

The VHF ground station is designed as a self contained unit or can be mounted in 19-inch rack systems or in an ATC desk.

The VHF ground station is designed to operate on a supply voltage of 110 V or 230 V, AC 50/60Hz. In DC operation, the VHF ground station is designed to operate on a voltage of 24 V.

The control circuit switches over to external DC voltage if the AC voltage supply fails.

Controls and indicators

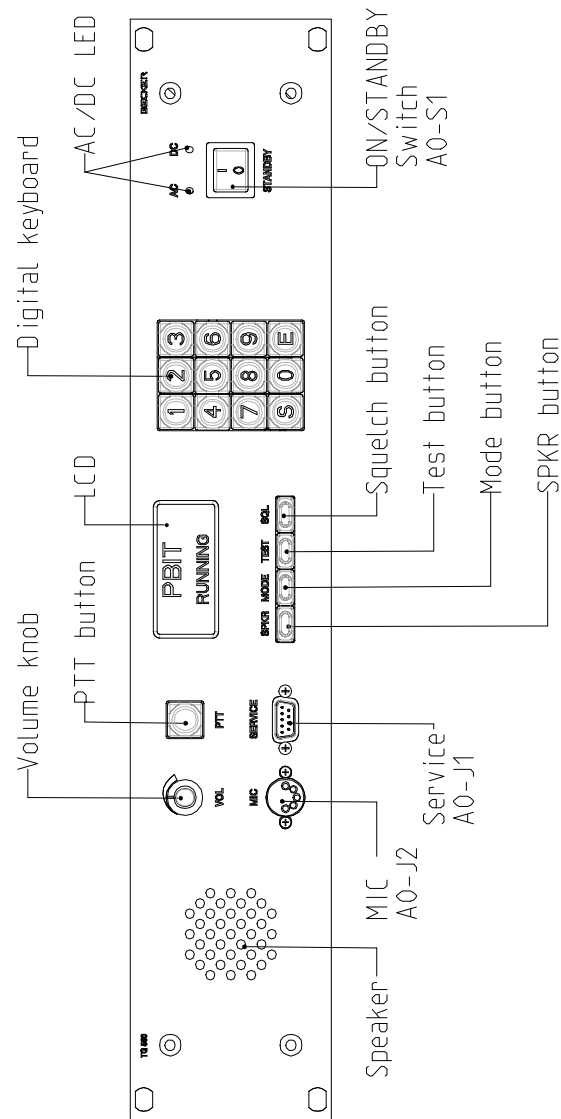

Service mode

The service-mode can be activated from display dimming mode by a long press of the "Mode"-Key.

The service-mode can be deactivated by momentarily pressing the "Mode"-Key. The station goes back to the previously selected standard or channel mode.



If the serial connection was successfully established between the station and the service PC, "ON LINE" is displayed, otherwise – "OFF LINE" as shown on.



In this mode the service connector, standard RS232 serial data port at the front panel is active for connection of a note-book PC.

Display dimming

Display dimming function is activated by a long press of the "Mode" key.:

The display as shown on:



If the "S"-key is pressed the backlight intensity is decreased. If the "E"-key is pressed the backlight intensity is increased. Display intensity can be changed in 10 Steps beginning with backlight switched off up to full backlight intensity.

If the "MODE" key is pressed for a short time, or if no key is pressed, within 5 seconds the station goes back to the previously selected mode.

Function of controls and indicators

Description	Function
ON/standby switch	Switching the station ON/OFF
Speaker key (SPKR)	Switching the internal speaker and external speaker ON or OFF
Mode key	<p>momentary press Selection of mode: Operating mode Channel mode</p> <p>long press Selection of mode: Dimming-mode (change from standard- or channel-mode to service-mode from dimming-mode to service-mode.</p>
TEST key	By pressing the test key the test function IBIT is activated
Squelch key	Switching the squelch ON/OFF
Key (E)	Use to acknowledge inputs
Key (S)	Storage key
Keys 0 - 9	Numerical keyboard
Volume control	Adjustment of volume
AC/DC LED	Indication AC or DC supply voltage
MIC	For connection of a microphone / head set
Service	For connection of a service computer

LCD (liquid crystal display) elements

Standard mode

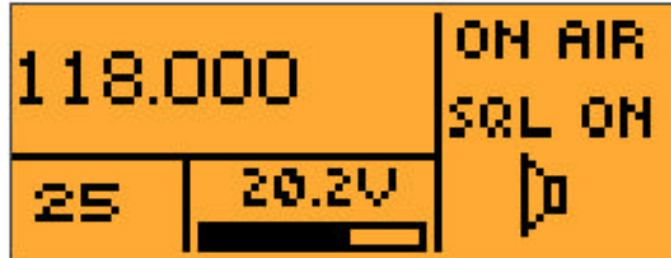

Description	Function
(top line)	Indication of active transmission/reception frequency (active frequency)
(bottom line 25)	Indication 8.33 or 25 kHz channel spacing
(bottom line 28.0 V)	Indication of DC supply voltage
(top line ON AIR)	Indication of transmitt mode
(bottom line SQL ON)	Indication of squelch ON/OFF (receive mode)
(bottom line)	Indication of speaker internal / external is switch ON

If the IBIT fails only active error and warning list is displayed.

If numerous errors are encountered during IBIT the error list is indicated. By pressing any key except for "S" the code of the next error is indicated, for example "E3 ANTERROR", "E35 RT5202ER", and so on, until the code of the last error is reached. If the code of the last error encountered is indicated and any key except "S" is pressed again, the code of the first detected error "Exx xxxxxxxx" is displayed and so on.

If the key "S" is pressed during error(s) code(s) output and there were no fatal errors the VHF ground station is switched to the operating mode as selected before the equipment was switched off.

If the key "S" is pressed during error(s) code(s) output and there were fatal errors flashing indication "ERROR" appears, all controls of the ground station except "MODE" key is disabled. By pressing the "E" key the VHF ground stations goes back to the errors list and so on.

It is possible, to go to service mode by pressing "MODE" key, if fatal error was detected.

CBIT functions

If the CBIT fails and the detected error is non-fatal or warning, an "error" flashing indication appears .

If the CBIT fails and the detected error is fatal, an "error" flashing indication appears permanently until the "E" button on the front panel is pressed. If "E" is pressed , the error list is displayed.

If the CBIT fails only active error and warning list is displayed.

If the IBIT fails and the detected error is non-fatal or warning, a flashing indication "ERROR" appears for 20 seconds. If during this time the "E" button on the front panel is pressed, the error list is displayed, otherwise the station is automatically switched to the operating mode as selected before the equipment was switched off.



If the IBIT fails and the detected error is fatal, a flashing indication "ERROR" appears permanently until the "E" button on the front panel is pressed. If the "E"-key is pressed, the error list is displayed.

If one error is encountered during IBIT the error codes appear, but without an arrow on the bottom side of LCD. Error codes E01, E02, E03, and so on, are indicated. For the list of Error's Codes and their severity level (fatal/non-fatal/warning) refer to the Built-in test description.

Channel mode

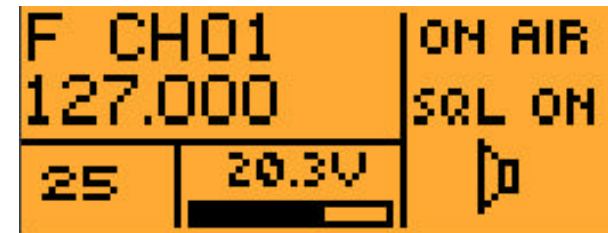

Description	Function
(top line)	Indication the selected storage channel
(top line)	Indication of active transmission/reception frequency (active frequency)
(bottom line 25)	Indication 8.33 or 25 kHz channel spacing
bottom line 28.0 V)	Indication of DC supply voltage
(top line ON AIR)	Indication of transmitt mode
(bottom line SQL ON)	Indication of Squelch ON/OFF (receive mode)
(bottom line)	Indication of Speaker internal and external is switch ON

Display dimming



Description	Function
Press the "S"-key	The backlight intensity is decreased
Press the "E"-key	The backlight intensity is increased.

Service mode



Indication service mode

Channel mode

Select storage mode using the "MODE" key. The last displayed storage channel appears in the upper left part of the LCD and the stored frequency is shown under the channel number.

If FREE channel number is selected "F" letter is displayed in the upper left corner of LC display (e.g. for CH01). Under the channel number the operating frequency channel name is indicated (e.g. 127.000).

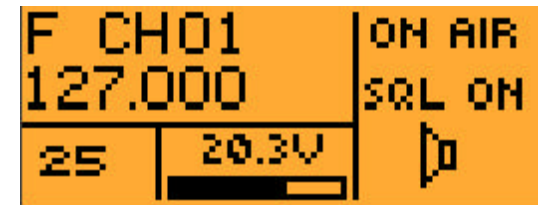

Test IBIT

The IBIT is started by pressing "TEST" button.

The indication is displayed during IBIT or at least for 2 seconds, if IBIT duration is shorter than 2 seconds.



Note

The interdependence of the operating channel name and real operating frequency of the transceiver is shown:

Channel Name	Channel Frequency	Channel Spacing
118.000	118.0000 MHz	25 kHz
118.005	118.0000 MHz	8.33 kHz
118.010	118.0083 MHz	8.33 kHz
118.015	118.0166 MHz	8.33 kHz
118.025	118.0250 MHz	25 kHz
118.030	118.0250 MHz	8.33 kHz
118.035	118.0333 MHz	8.33 kHz
118.040	118.0416 MHz	8.33 kHz
118.050	118.0500 MHz	25 kHz
118.055	118.0500 MHz	8.33 kHz
118.060	118.0583 MHz	8.33 kHz
118.065	118.0666 MHz	8.33 kHz
118.075	118.0750 MHz	25 kHz
118.080	118.0750 MHz	8.33 kHz
118.085	118.0833 MHz	8.33 kHz
118.090	118.0916 MHz	8.33 kHz
118.100	118.1000 MHz	25 kHz
...
155.975	155.9750 MHz	25 kHz
155.980	155.9750 MHz	8.33 kHz

Connecting sockets rear side

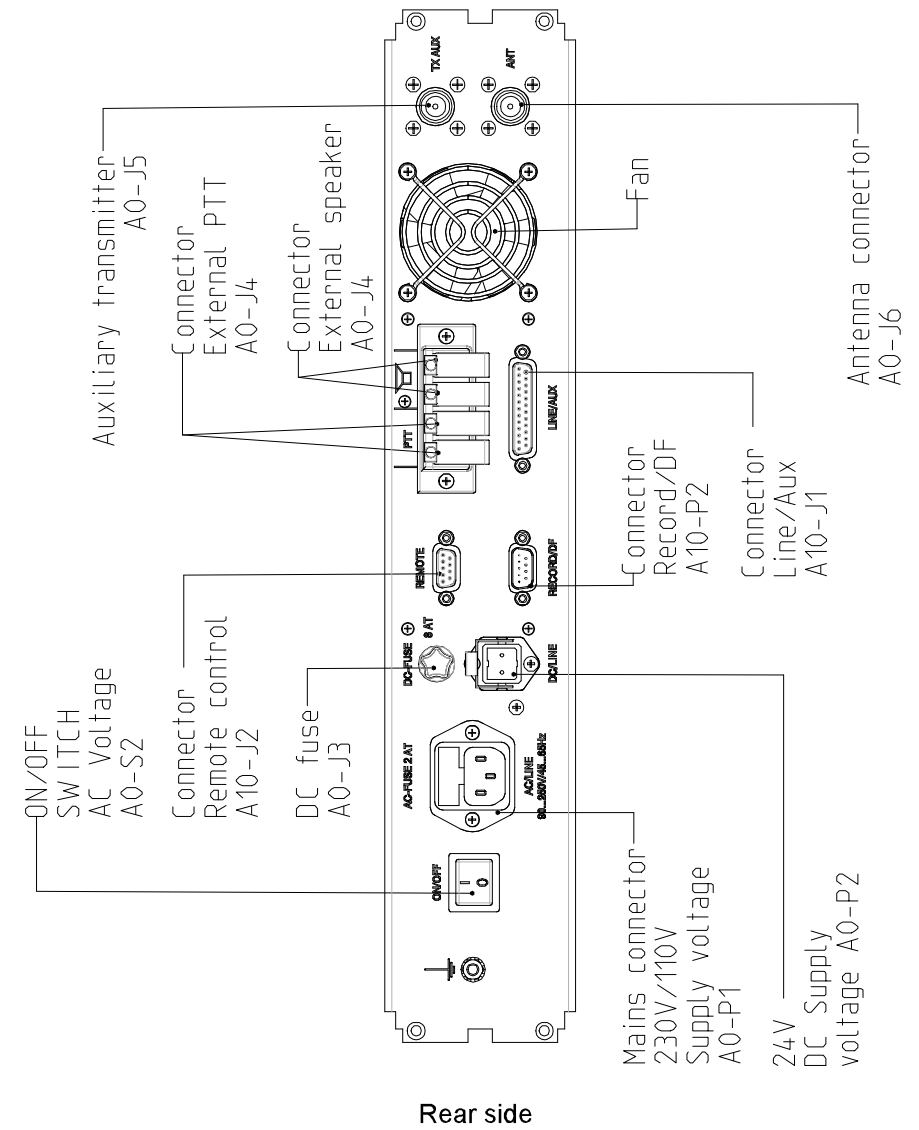

Operating instructions

❑ Switching on the VHF ground station

Switch on the station using the ON/OFF STANDBY switch on the front plate. The "Becker Logo" appears for 2 seconds on the LC display

Note

The equipment works with AC-power as standard. If the AC-power fails, an automatic switch over to DC-power is performed. If AC-power becomes available again, automatic switch over back to AC-power is performed.

Depending on which power the station is operating, the associated indication at the front panel (LED green) is illuminated.

If the station switches from AC to DC-power or vice-versa, the station is operable with the same functions and settings as before.

❑ Power on Built in Test (PBIT)

The PBIT is started when the station is switched on. In the LC display appears for 2 seconds "BECKER Logo"



❑ Storage procedure

When the "S" key is pressed in **standard mode** a storage operation is activated. Immediately after pressing "S" key the frequency channel name in the upper part of the display disappears. "CH" appears in the top of the display. Underneath the operating channel name appears. The required storage channel is selectable by pressing numeric keys 0-9.



Incorrect input is ignored (digits other than 0,1,2 in the first position and channel numbers greater than 20).

If selected channel is FREE, "F" letter appears. If selected channel was used earlier, "F" letter does not appear and user can overwrite previous data.

If incorrect (channel) number is input, the bottom line CHxx must be inverted for 1 seconds and the indication goes back to the previous indication.

The storage is acknowledged by pressing the "E" key. After acknowledgement the indication goes back as described for standard mode.

If the "E" button is not pressed within 10 seconds after pressing digital key, the station goes back to the standard mode indication.

The symbol "ON AIR" in the upper right part of the display appears if TX is active, or if RF-SO function is active.

□ Setting operating frequency

Set the operation frequency of the station with the keys 0 - 9. Immediately after key 0-9 is pressed the frequency channel name indication and the channel spacing go out. The digits move from right to left on each further input.

Note

If "E"- button is pressed, the frequency input is acknowledged and stored.

If the "E"-button is not pressed within 10 seconds after pressing numerical key, the unit goes back to the previously set frequency.

If more than six digits are edited no more is accepted and the frequency channel name indication is inverted for 2 second and the station goes back to the previously set frequency.

If less than 6 digits are edited and if the "E"- button is pressed the frequency channel name indication is inverted for 2 second and the station goes back to the previously set frequency .

If an incorrect input is made (for example digit 3 in the first position or the extended channel name) the input of this digit is ignored and frequency channel name indication is inverted for 2 seconds, then the station waits for 10 seconds for correct input. If no correct input is made within 10 seconds the station goes back to the previously set frequency.

Afterwards, the indication changed the indication as shown on and stays until PBIT is finished for minimum 1 second.



If the PBIT is completed successfully, the station automatically switches to the mode which was selected before switch-off.

If the PBIT **fails and the detected error is non-fatal**, an "ERROR" flashing indication appears in the LC display for 20 seconds. If, during this time, the "E" button on the front panel is pressed, the error list appears in the LC display. Otherwise, the unit switches automatically to the operating mode as selected before the equipment was switched off.

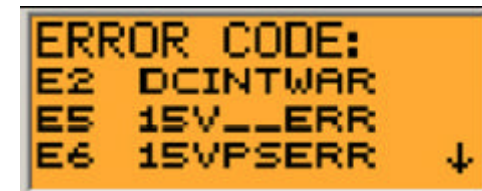

If the PBIT fails and the detected error is fatal, an "ERROR" appears in the LC display permanently until the "E" button on the front panel is pressed. If "E" is pressed, the error list is displayed.

This error event is stored in NOVRAM.

If the PBIT fails and the detected error is warning, an "ERROR" flashing indication appears in the LC display for 20 seconds. If, during this time, the "E" button on the front panel is pressed, the error list appears in the LC display. Otherwise, the unit switches automatically to the operating mode as selected before the equipment was switched off. This error event is not stored in NOVRAM.

If up to three errors are encountered during PBIT, error codes appear in the LC display but without arrow on the right bottom corner of the LCD. Error codes E01, E02, E03, and so on, are indicated in the LCD with short description.

If numerous errors are encountered during PBIT, error codes appear in the LC display. By pressing any key except for "S" and "E" the code of the next error is indicated, for example "ERROR 2 : E03", "ERROR 3 : E56", and so on, until the code of the last error is reached. If the code of the last error encountered is indicated and any key except for "S" is pressed again, the code of the first error "ERROR1: Exx" is indicated and so on.

If the key "S" is pressed during error(s) code(s) indication and there were non-fatal errors or warnings the station switches to the operating mode as selected before the equipment was switched off.

If the key "S" is pressed during error(s) code(s) output and there were fatal errors flashing indication appears. All controls of the station are disabled. By pressing "E" to go back to the errors list and so on.

❑ Operation of the standard mode

The station performs various functions which are covered by two operating modes. The mode is selected by briefly pressing the "MODE" key.

Standard mode

The last displayed active frequency is shown upper left part of the LCD. Select standard mode with the "MODE" key.

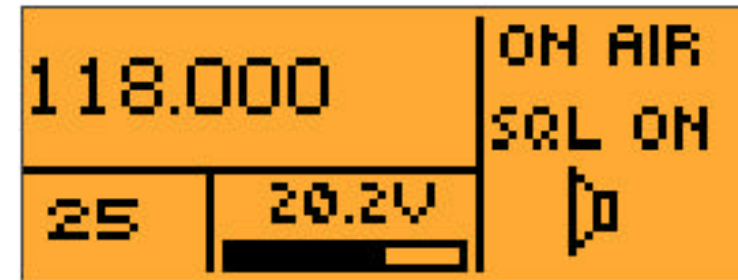

Note

"SQL ON" indication appears in the right middle part of the display if the squelch is switched ON, otherwise "SQL OFF".

The loudspeaker symbol appears in the right bottom part of the LCD if the speaker (internal or external) is switched on, otherwise the symbol is not displayed.

When the station is working on 28 V DC voltage, a numeric and bar-graph indication appears in the left bottom part of the LCD. If the external D.C. voltage falls below 20V, the voltage indication flashes.

If the station is supplied from mains power supply (AC) the indication of DC voltage disappears.