

Audio Control Unit ACU6100



Operating Instructions

Issue 8 / February 2015
Article No. 0590.363-071

Table of Contents

	page
Important	5
Introduction	5
Intercom system	6
Section 1 General	6
Section 2 System Description	6
Section 3 OPERATION	7
3.1 Operating controls	7
3.2 Description and function of the operating controls and indicators	7
3.3 Operating instructions	9
3.3.1 Preparations (power-up test)	9
3.4 Transceiver operation	10
3.4.1 Transceiver monitoring	10
3.4.2 Individual transceiver channel volume adjustment	10
3.4.3 Monitored TX-channel visualization	10
3.4.4 Main volume adjustment	10
3.5 Selection of transmission mode	11
3.5.1 Selecting a radio for transmission	11
3.5.2 Selection of dual or multi transmission mode	11
3.5.3 Selection of intercom PTT	11
3.5.4 Forced monitoring	11
3.5.5 Transmission mode	12
3.5.6 Dual transmission	13
3.5.7 Multi transmission mode	14
3.6 Receiver operation	14
3.6.1 Receiver monitoring	14
3.6.2 Individual receiver channel volume adjustment	15
3.6.3 Monitored RX-channel visualization	15
3.6.4 Main volume adjustment	15
3.6.5 Voice filter activation	15
3.6.6 Loudspeaker operation	16
3.7 Intercommunication	17
3.7.1 Virtual Intercom Circuits	17
3.7.2 Cockpit "ISOL/CALL" Functionality	19
3.7.3 Cabin "ISOL/CALL" Functionality	19
3.8 Intercom activation	19
3.8.1 Voice Controlled Intercom	20
3.8.2 VOX level adjustment	20
3.8.3 PTT controlled intercom	20
3.8.4 External switch controlled intercom	20

Operating Instructions ACU6100

3.8.5	IC volume adjustment	21
3.8.6	Winchman intercom	21
3.8.6.1	Winchman VOX level functionality	21
3.8.6.2	Winchman volume level functionality	22
3.8.7	Emergency CALL function	22
3.9	Selective CALL function	22
3.9.1	Allocation of "Selective CALL"	22
3.9.2	Selective CALL indication	22
3.9.3	Selective CALL forced monitoring	22
3.10	Built in test	23
3.10.1	Power-up built in test (P-BIT)	23
3.10.2	Continuous built in test (C-BIT)	23
3.10.3	Initiated built in test (I-BIT)	23
3.11	Emergency operation	24
3.11.1	Slave operation	24
3.11.2	Back-Up operation	24
3.11.3	Back-Up switch activated	25
3.11.4	Automatic activation	25
3.12	Special Version Audio Control Unit ACU6100-X-(XXX0) Intercom /PTT Switch on ACU	25
3.13	Special Version Audio Control Unit ACU6100-X-(X9X) (RX Version)	26
3.14	Selection of Relay Mode	27
3.15	Special Version Audio Control Unit ACU6100-X-(XXX5) Fixed Wing Version	28
Section 4 List of Abbreviations		29
Fault description		30

Important **Important**

Carefully read these operating instructions before attempting to operate the Audio Control Unit.

Keep these operating instructions for future reference. They contain important safety and operating instructions for the Audio Control Unit.

Introduction **Introduction**

Thank you for purchasing the BECKER Audio Control Unit.

If you have any questions regarding the operation of the Audio Control Unit, please get in touch with your nearest Becker Dealer or with Becker Customer Service.

The CAUTION; WARNING and NOTE highlights have following meanings:

WARNING	Failure to comply or incorrect compliance with these instructions or procedures can lead to injuries or fatal accidents
CAUTION	Failure to comply, or incorrect compliance, with these instructions or procedures can lead to damage to equipment.
NOTE	Feature to which attention should be drawn.

Intercom System

Section 1 General

The intercom system is part of the aircraft's radio and audio system. It enables the crew to communicate with each other and to monitor the radio, identification and warning signals

Section 2 System Description

The Intercom System provides the following modes of operation:

- Hot mike operation for all crew members.
- Intercommunication between pilot and copilot.
- Intercommunication among the passengers.
- Connected or separated intercommunication for cockpit and cabin crews.
- Intercommunication between cabin crew and pilots. If a cabin crew member pushes a "CALL" button, a call signal is generated {configurable} and is audible in the headsets cockpits. Simultaneously a call annunciator will illuminate. The pilots then may communicate individually.
- Individual transmitter operation for both, pilot and copilot, with either one of the radios available or two of it for dual transmission (configurable), including sidetone monitoring.
- Individual transmitter operation for the cabin crew, including sidetone monitoring
- Discrete or collective radio reception of audio signals for the pilots and crew.
- Some special mission functions

Section 3 OPERATION

3.1 Operating controls

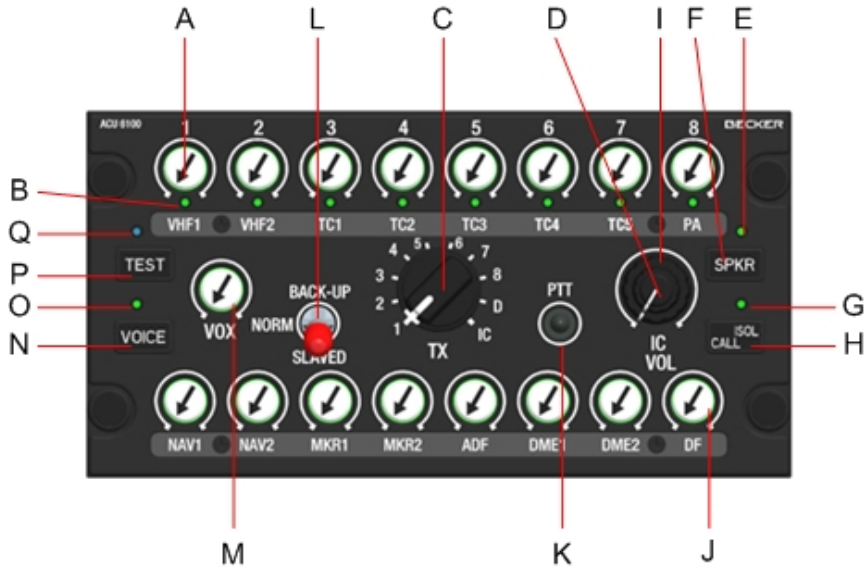

Figure 3-1 Front panel of the Audio Control Unit with generic button-inscription

3.2 Description and function of the operating controls and indicators

Item	Control / Indicator	Description	Function
A	TX1 to TX8 controls	8 potentiometer with push-push switches	On/Off switch for every TX channels and individual volume adjust for audio monitoring
B	TX indicators 1 to 8	8 LED (green)	Indication of individual TX channel status LED on = channel is preselected for transmission LED blinking = transmission is active LED blinking = Selective "CALL" is active fast
C	Transmitter selector switch	Rotary switch with 10 lock positions	Position 1 to 8 preselection of TX channel for transmission Position D selection of 2 predefined TX channels for dual transmission mode Position D selection of multi transmit mode, if configured Position IC Intercom PTT mode
D	IC volume control	Potentiometer	Volume adjustment for intercom

Operating Instructions ACU6100

Item	Control / Indicator	Description	Function
E	“SPKR” indicator	LED (green)	LED on = Speaker is on LED off = Speaker is off
F	“SPKR” button	Push-button	On/Off switch for audio monitoring via the speaker
G	“ISOL/ CALL” indicator	LED (green)	LED on = cockpit and cabin intercom circuits are isolated LED off = cockpit and cabin intercom circuits are connected LED blinking = intercom request “CALL” is active
H	“ISOL/ CALL” button	Push-button	Cockpit connect or truncate the cockpit and cabin intercom circuits Cabin initiates an intercom request “CALL” if the intercom circuits are truncate
I	Volume control	Potentiometer,	Main volume control
J	RX1 to RX8 controls	8 potentiometer with push-push	On/Off switch for every RX channels and individual volume adjust for audio monitoring
K	PTT switch optional PTT/IC switch or MASK/MIC switch	Momentary switch with 2 key positions Toggle switch with two locking positions	Switch pressed = selected transmitter is keyed Switch released = selected channels are monitored Option IC-Switch = Activation IC operation External relay control for MASK / MIC switch over
L	BACK-UP switch	Toggle switch with 3 locking positions or Toggle switch with 2 lock positions	Position BACK-UP = emergency operation Position NORM = normal operation Position SLAVED = slave operation Position EMER = emergency operation Position NORM = normal operation
M	VOX level adjustment VOX ON/OFF switch	Potentiometer with push-push switch	VOX sensitivity selection ON/OFF switch for VOX activation
N	“VOICE” button	Push-button	On/Off switch for VOICE filter (for configured -RX channels)
O	“VOICE” indicator	LED (green)	LED on = voice filter is active LED off = voice filter is not active
P	“TEST” button or “MKR / MUTE” button	Push-button	Activation of IBIT (test function) Activation of Maker mute function
Q	“TEST” indicator	LED (yellow)	LED on = internal self test is running LED blinking = the internal selftest detected an failure

3.3 Operating instructions

3.3.1 Preparations (power-up test)

1. Switch on the unit by using the audio selector master switch (circuit breaker).
2. When the Audio Control Unit is powered, the device starts an internal self test procedure. All the microprocessors and memories are tested as well as data transfer between Audio Control Units and Remote Electronic Unit.

While test is running, the LED above "TEST" push button illuminates. The test needs about 4 seconds.

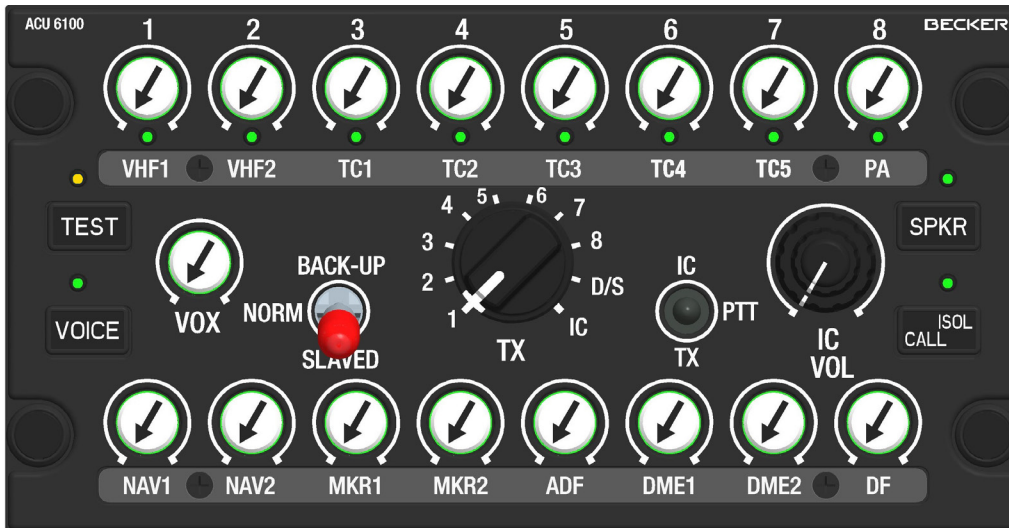

Figure 3-2 Power-up test

After test, following results are shown:

- No failure detected yellow LED is off; the system is in normal mode
- Failure detected yellow LED is blinking

If the internal test routine detected a failure (yellow LED is blinking), the operator has 2 possibilities:

- By pressing the "TEST" button, failure can be acknowledged. In case of a permanent problem inside the system, it will be detected by continuous self test routine and indicated again.
- Switching into slaved or emergency mode by using the "BACK-UP" switch.

3.4 Transceiver operation

3.4.1 Transceiver monitoring

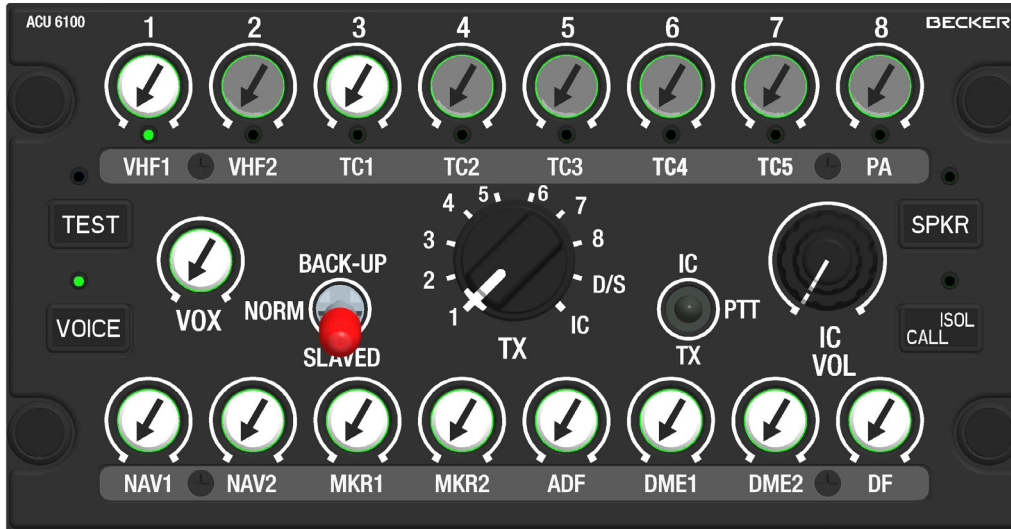

Figure 3-3 Transceiver monitoring

For transceiver monitoring, a TX-channel is activated by push release of the respective knob.

- Knob released monitoring ON
- Knob pressed monitoring OFF

Several transceivers may be selected for monitoring at the same time.

3.4.2 Individual transceiver channel volume adjustment

The individual volume for the monitored channels can be selected by turning the respective knob.

3.4.3 Monitored TX-channel visualization

The activated TX-channel (released) knobs are illuminated.

By looking at the panel from an angle that's unequal to the rectangular top view, it's easy to detect the activated and deactivated channels.

An arrow on top of each knob helps the user to pick the selected volume of the several channels quickly.

3.4.4 Main volume adjustment

Main volume can be adjusted at any time by turning just the VOL control. This action adjusts the sum volume of all activated TX- and RX-channels and the fixed inputs 4 to 6.

3.5 Selection of transmission mode

3.5.1 Selecting a radio for transmission



Figure 3-4 Selecting a radio for transmission

For transmission with an individual radio, the transceiver is pre-selected by means of the TX-selector rotary switch in the centre of the Audio Control Unit. In the given example TX-channel 1 is pre-selected for transmission. The green LED illuminates (TX channel 1).

3.5.2 Selection of dual or multi transmission mode

Positions 9 of the TX-selector rotary switch labelled with "D" is for dual or multi transmission mode. By system configuration at installation time, 2 out of the 8 TX-channels can be defined for usage in dual transmission mode.

3.5.3 Selection of intercom PTT

The last position (by turning clock wise) of the TX-selector rotary switch selects the "Intercom by PTT" mode.

3.5.4 Forced monitoring

The reception signal of the radio which is pre-selected for transmission is monitored, even if it was not active for monitoring before (forced monitoring).

Using the respective knob, the monitoring volume can be adjusted.

Forced monitoring can be deactivated during installation setup by configuration.

With activated "Forced Monitoring", in the following example, TX-channel 1 would be audible thus it is not manually activated (knob not released).



Figure 3-5 Forced monitoring

3.5.5 Transmission mode



Figure 3-6 Transmission mode

By pressing a PTT switch (on panel or external), the following actions will result:

- The selected transmitter will be keyed.
- The green LED below the associated channel volume knob is blinking.

Note:

During transmission, all received signals possibly selected, are muted as well as signals originating from aircraft intercommunication.

The muting can be deactivated during installation setup by configuration.

Only those warning tones which have been programmed as essential during installation setup, are still audible when transmitting.

If loudspeakers are provided and if the one related to the individual control unit had been switched on prior to transmitting, it will be muted to avoid acoustic feedback to the micro- phone.

Operating Instructions ACU6100

By speaking into the microphone while in transmission mode, the following actions will result:

- The activated transmitter is modulated.
- A sidetone is audible with a volume that is in accordance with the preselection in the installation setup. The individual volume for the monitored channels can be selected by turning the respective knob.
- The TX indications (blinking LED) assigned to an individual transmitter is active on all ACUs when keyed by any operator.
- Any other transmitter could be modulated by different operators simultaneously.

By releasing the PTT switch (on panel or external), the following actions will result:

- The transceiver turns back to receive mode.
- The green LED lights up (stops flashing).
- All previously selected signals, intercom, and warning tones are resumed.
- If the loudspeaker was activated before pressing PTT, it is switched on again.

3.5.6 Dual transmission

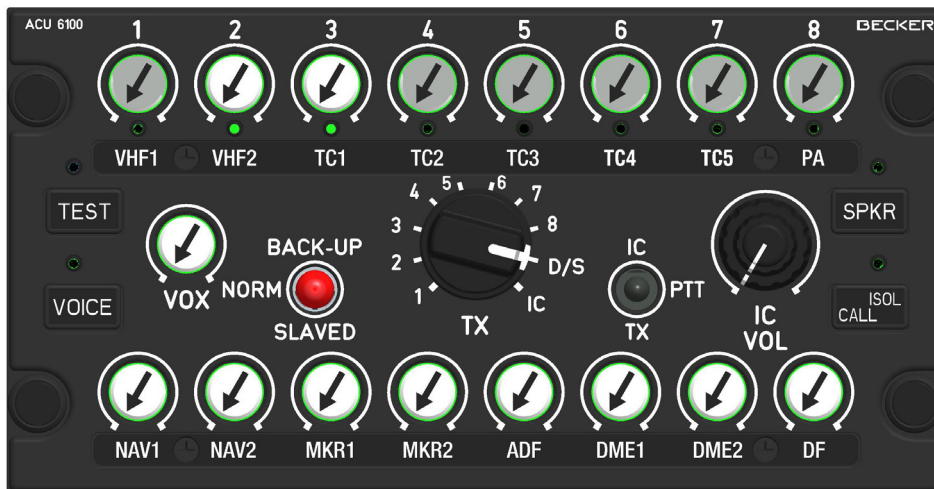

Figure 3-7 Dual transmission mode

If the TX-selector rotary switch is turned to position "D", the operator activates 2 transceiver simultaneously for dual transmission. The green LED's (transceiver monitoring) from the selected transceivers illuminate. The selection of the two transceivers for dual transmission is configured during installation setup of the control unit.

By pressing a PTT switch (on panel or external), the transmission is indicated by the corresponding green LED's blinking as long as the PTT switch is held.

By configuration the system is able to be configured for Dual TX or Multi TX operation. The dual transmission mode can be blocked by system configuration.

3.5.7 Multi transmission mode

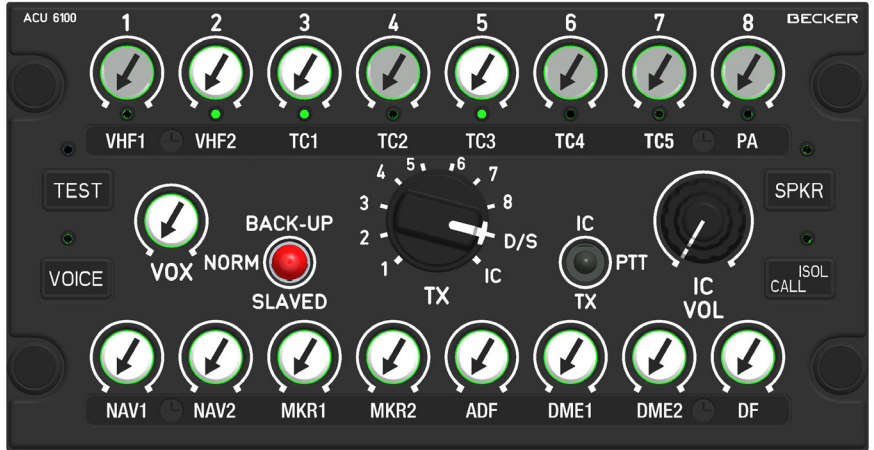

Figure 3-8 Multi transmission mode

If the TX-selector rotary switch is turned to position "D", the operator activates (TX-knob released) several transceivers simultaneously for transmission. The green LED's (transceiver monitoring) from the selected transceivers illuminate. The selection of the function for simulcast is configured during installation setup of the control unit.

By pressing a PTT switch (on panel or external), the transmission is indicated by the corresponding green LED's blinking as long as the PTT switch is held.

By configuration the system is able to be configured for Dual TX or Multi TX operation. The simulcast transmission mode can be blocked by system configuration.

3.6 Receiver operation

3.6.1 Receiver monitoring

For receiver monitoring, a RX-channel is activated by push release of the respective knob:

- Knob released monitoring ON
- Knob pressed monitoring OFF



Figure 3-9 Receiver operation

Several receivers may be selected for monitoring at the same time.

In the given example, RX-channel 1, 2 and 6 are selected for monitoring. RX-channel 5 is not audible, even though the volume knob is not in the far left (ccw) position.

3.6.2 Individual receiver channel volume adjustment

The individual volume for the monitored channels can be selected by turning the respective knobs.

3.6.3 Monitored RX-channel visualization

The activated RX-channel (released) knobs are illuminated.

By looking at the panel from an angle that's unequal to the rectangular top view, it's easy to detect the activated and deactivated channels.

An arrow on top of each knob helps the user to pick the selected volume of the several channels quickly.

3.6.4 Main volume adjustment

Main volume can be adjusted at any time by turning the VOL control. This action adjusts the sum volume of all activated TX- and RX-channels.

3.6.5 Voice filter activation

The system has the possibility to activate a 1020Hz notch filter for all the RX-channels. This is to suppress identification codes in the incoming audio signals from navigation receivers (e.g. for listening to weather information).

In the configuration of the system, the system integrator can define the RX-channels that will have this filter.

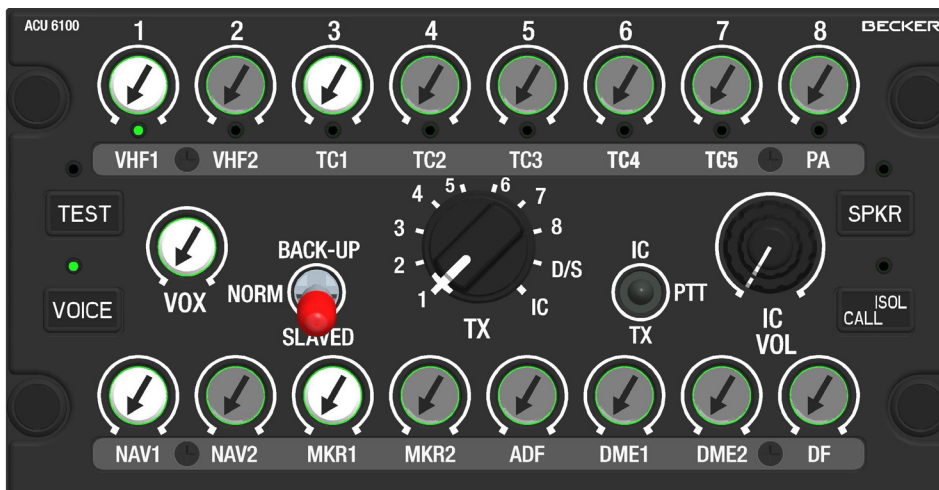

Figure 3-10 Voice filter activation

Operating Instructions ACU6100

Whilst operating, the filter can be activated and deactivated by pressing the "VOICE" push button. The status of voice filter activation is visible by a green LED in top of that push button:

- "VOICE" LED on voice filter is active
- "VOICE" LED off voice filter is not active

3.6.6 Loudspeaker operation

Note:

The DVCS6100 system provides two speaker channels which are assigned in the standard version to ACU1 and ACU2.

Pressing the "SPKR" button briefly, switches on the loudspeaker that is related to this control unit. All selected TX/RX channel signals and warnings are reproduced through the loudspeaker. The green LED above the button indicates the speaker mode.

Pressing the key once again, the speaker is switched off and the LED goes off.

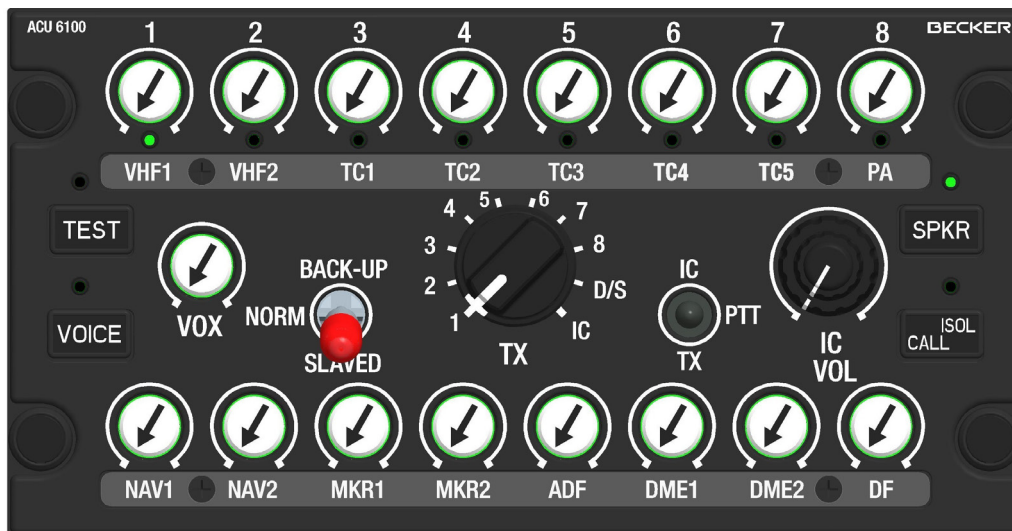

Figure 3-11 Loudspeaker operation

When speaker mode is active with an individual Audio Control Unit, voice controlled intercommunication (VOX) is disabled.

Intercom is still possible by activating the external IC-PTT button or by pressing the TX-PTT button while the TX-selector rotary switch is in position "IC". In both cases, the loudspeaker is muted to avoid feedback.

3.7 Intercommunication

3.7.1 Virtual Intercom Circuits

There are four Intercom Circuits provided by the DVCS6100 System.

1. Cockpit Crew
2. Cabin Crew
3. Third Circuit (controlled by a external switch, refer to the REU6100 manual)
4. IC-Ring Line (connected to the cabin, Cockpit or 3rd intercom circuit; configurable by the CSW - Software).

Two of the intercom circuits (Cockpit and Cabin) can be direct controlled by the Control Unit.

The Intercom between cockpit and cabin can be truncated by pressing the “ISOL/CALL” push button. When the intercom mode between cockpit and cabin is interrupted, the green LED above the “ISOL/CALL” button is active.

Intercom extension for passengers:

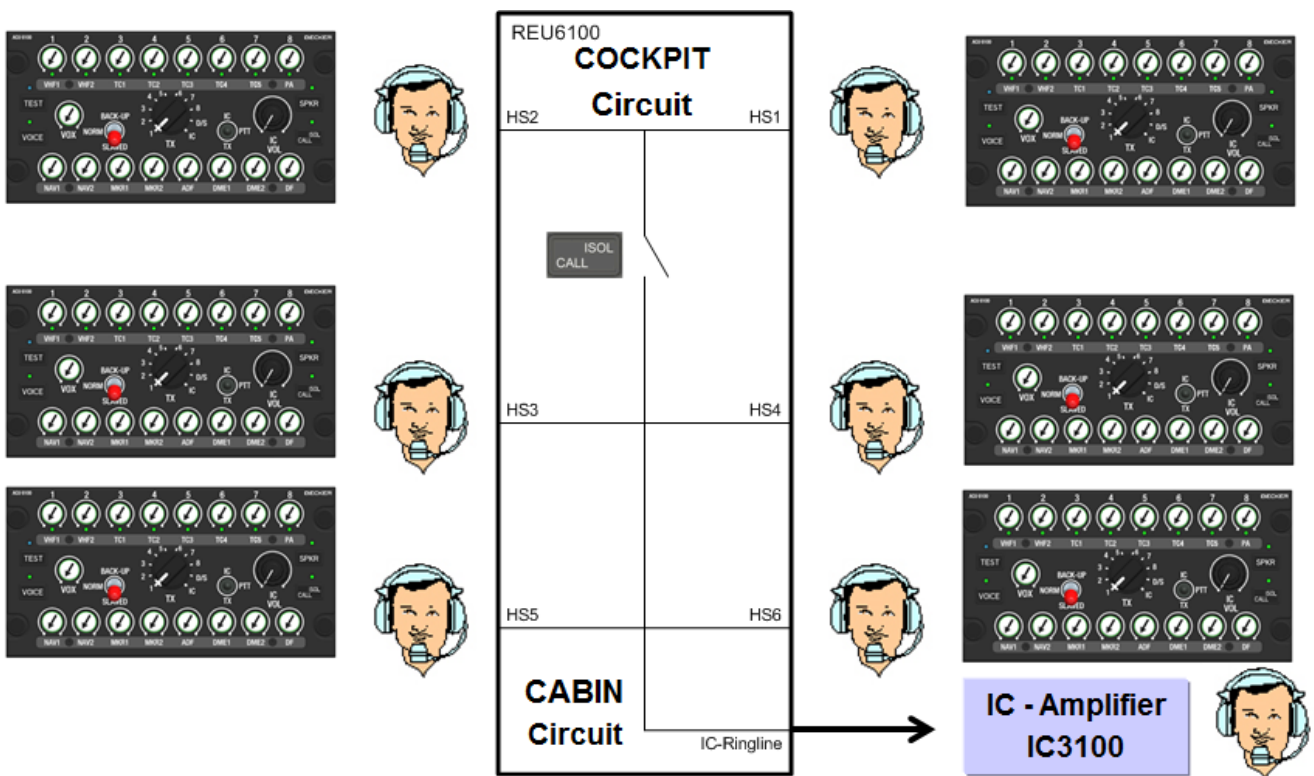

Figure 3-12 Virtual Intercom Circuits

By using an additional intercom amplifier (e.g. Becker IC3100) passengers can be connected with the intercom system. These passengers are representing a fourth intercom circuit which is connected with the cabin intercom circuit of the DVCS6100 system. It can be truncated by an external switch which is not shown in the above diagram.

Intercom extension for Ground Crew:

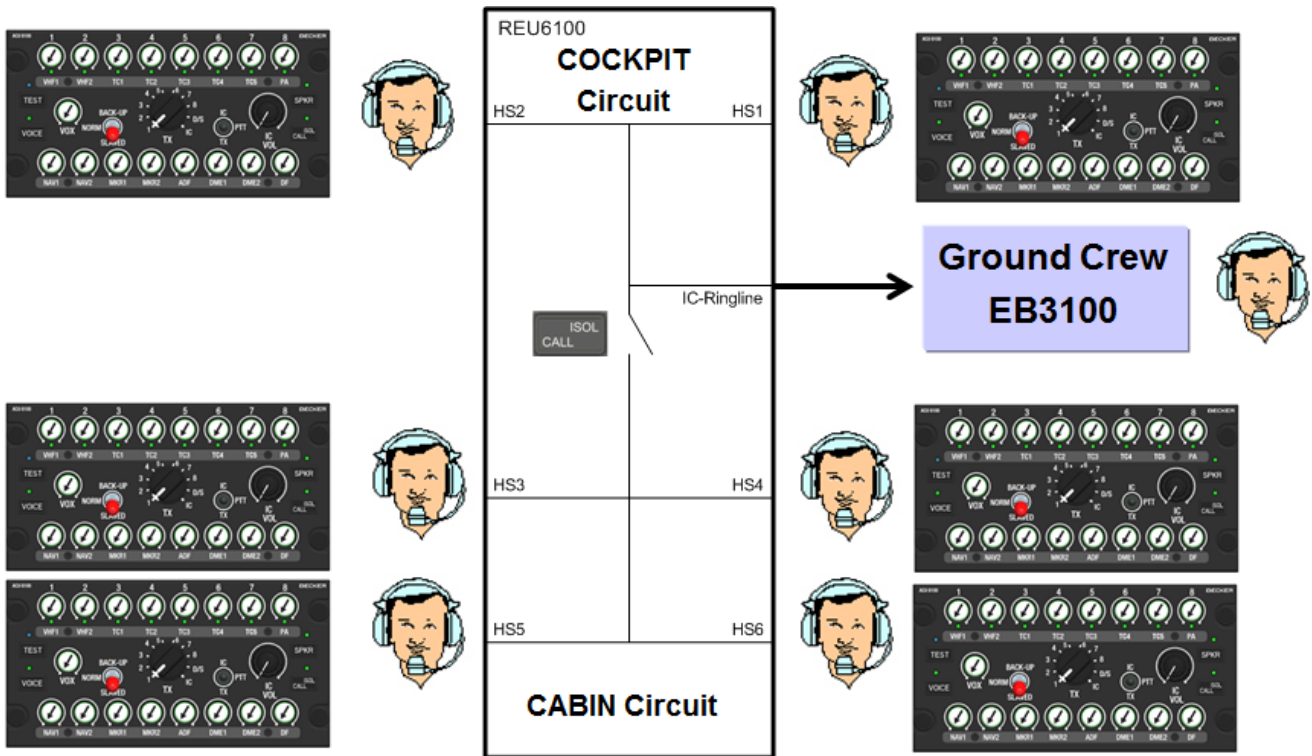

Figure 3-13 Intercom extension for Ground Crew

By using an additional ground crew box (e.g. Becker EB3100) ground crew can be connected with the intercom system. That ground crew is representing a fourth intercom circuit which is connected with the cockpit intercom circuit of the DVCS6100 system.

3.7.2 Cockpit "ISOL/CALL" Functionality

In the cockpit, the "ISOL/CALL" button is used to toggle the connection/disconnection between the cockpit and the cabin intercom circuits.

A LED above this button indicates the actual status of the connection:

- LED on → cockpit and cabin intercom circuits are isolated
- LED off → cockpit and cabin intercom circuits are connected

3.7.3 Cabin "ISOL/CALL" Functionality

The "ISOL/CALL" button on the cabin ACUs gives the cabin passengers the possibility to call for a connection. The cockpit crew can react to this call by ending the isolation mode.

The LED above the "ISOL/CALL" button shows the call status in the following way:

- LED off Cockpit and cabin intercom circuits are connected
- LED blinking The "CALL" button was pressed and the system is in call mode. By pressing the "ISOL/CALL" key at his Audio Control Unit the pilot or copilot can re-establish the connection between the passengers. While the LED indications are blinking, a CALL tone is audible in the cockpit. The "CALL" tone can be enabled/disabled by configuration.
- LED on The intercom system is in isolation mode

If the system is in call mode (blinking LED), there are two possibilities:

- the cockpit crew leave the isolation mode and connect the intercom circuits (LED off).
- the cabin crew presses the "CALL" button once again and the system stays in isolation mode (LED on).

If the intercom circuits are connected (no isolation mode), the "ISOL/CALL" button on the cabin ACUs have no function.

Note:

For some special mission profiles also the cabin crew must be able to isolate the cabin crew from the Cockpit crew circuit. Cabin operator can only disconnect the two intercom circuits. This feature can be enabled in the configuration setup.

3.8 Intercom activation

Intercommunication between the different users can be activated in three ways:

- Voice controlled
- PTT controlled
- IC Switch on the control panel (optional) or External Switch controlled

3.8.1 Voice Controlled Intercom

In positions "1" to "8" and "D" of the TX selector rotary switch, Voice Controlled Intercom (VOX) is established without the need for any further action (assuming no transmitter is keyed).

Voice Controlled Intercom can be activated or deactivated by switching functionality of the VOX knob.

- VOX knob released Voice Controlled Intercom ON
- VOX knob impressed Voice Controlled Intercom OFF

The switch function of the VOX knob can be activated or deactivated by the Configuration Software.

3.8.2 VOX level adjustment

The VOX level of the microphones associated with each ACU can be adjusted independently for each ACU by turning the VOX potentiometer knob. The VOX potentiometer knob can be impressed in the same way as the channel volume knobs.

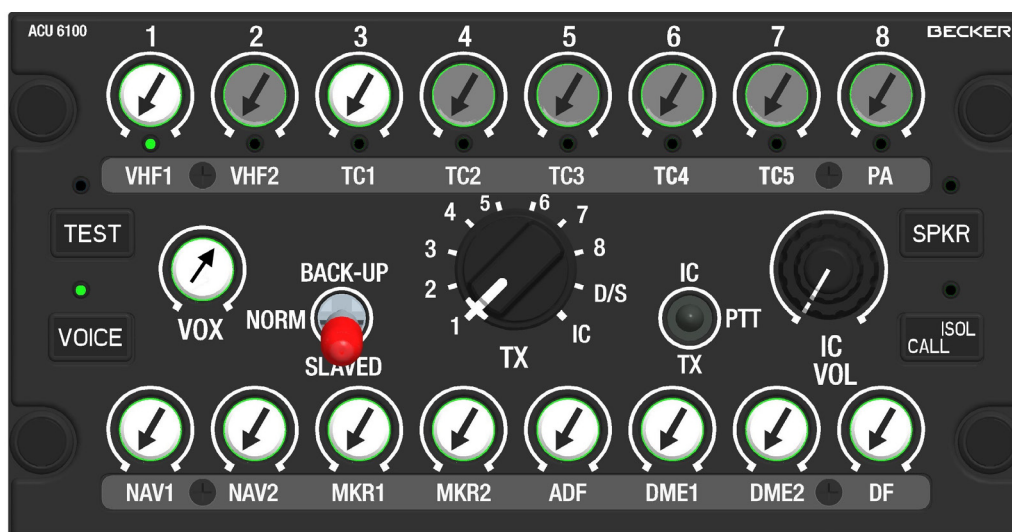

Figure 3-14 VOX level adjustment

3.8.3 PTT controlled intercom

Setting the TX selector to position IC, enables intercom by using the PTT button. In this case, the mike signal is forwarded to the intercom amplifier when the PTT switch is pressed only.

3.8.4 External switch controlled intercom

Each ACU supports an external momentary or 2-state switch for activation of a "Hot Mike Mode". If this switch is activated, the mike line is "open" and the signal is forwarded directly to the intercom amplifier.

3.8.5 IC volume adjustment

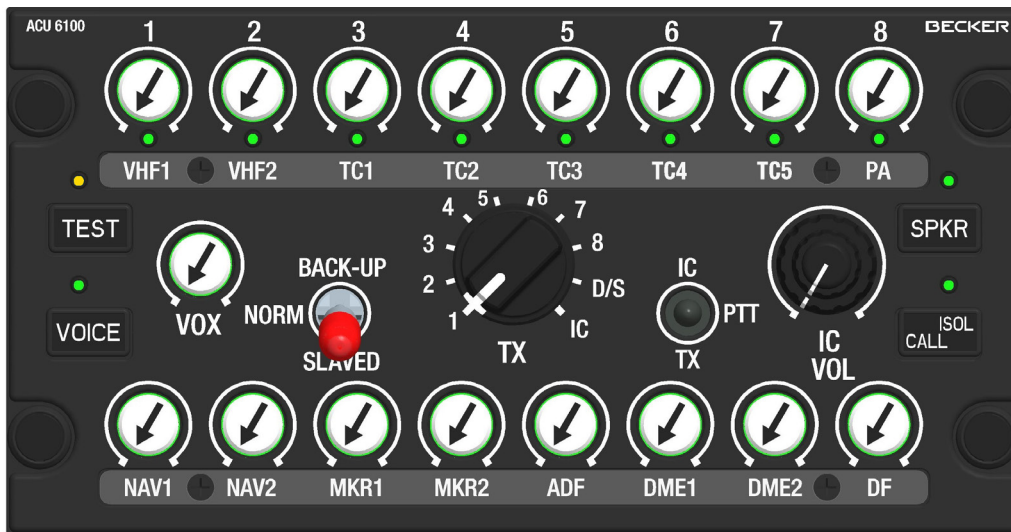

Figure 3-15 IC volume adjustment

For individual intercom volume adjustment, the ACU provides a dedicated potentiometer on the front panel. The intercom volume is independent from the main volume.

The transmission mode always has a higher priority than the intercommunication mode. If an operator activates the transmission mode for any transceiver, the ACU stops its "VOX" or "HOT MIKE" mode and carries out transmission mode. Other ACUs are not affected and their operators may continue intercommunication.

3.8.6 Winchman intercom

By pressing the special external push button the winchman function is activated.

With this, the winchman is able to increase the VOX level and the main volume for his headset. The external push buttons (connected via discrete input lines) are mounted separately from the corresponding ACU in the winchman working area (near the cabin door).

By configuration, it is possible to assign the winchman functionality to any ACU or headset without ACU.

The following sub paragraphs describe the winchman external buttons functionality in detail.

3.8.6.1 Winchman VOX level functionality

If the VOX level push button is pressed for a short time (0.3s to ≤ 3s), the VOX level is increased step by step, until the maximum value is reached. If the VOX level push-button is pressed for a time ≥ 3s, the VOX level will be reset to the value selected on the corresponding ACU panel. The VOX level can be reset too, when the winchman function is switched off and the volume control or VOX control on the ACU is changed.

3.8.6.2 Winchman volume level functionality

If the winchman volume push button is pressed a short time (0.3s to ≤ 2s), the volume level is increased by one step, until the maximum value is reached. If the winchman volume push button is pressed for a time ≥ 3s, the volume level will be reseted to the value selected on the corresponding ACU panel. The VOX level can be reseted also, when the main volume control or VOX control on the related ACU is changed.

3.8.7 Emergency CALL function

The Audio Control Unit provides an “Emergency CALL” (E-CALL) via a dedicated discrete input. If this discrete input is activated, the “E-CALL” tone is audible for cockpit ACU operators. The “E-CALL” tone is different from the intercom request CALL- tone.

The “E-CALL” functionality can be deactivated via system configuration.

3.9 Selective CALL function

A “Selective CALL” functionality is provided by the Audio Control Unit in a configurable way. The system detects selective call status via a discrete input line.

The behaviour of the Audio Control Unit Selective CALL functionality can be selected by configuration of the system.

3.9.1 Allocation of “Selective CALL”

The “Selective CALL” function can be allocated to one of the 8 TX-channels white system integration setup.

3.9.2 Selective CALL indication

As long as the “Selective CALL” discrete input is activated, the LED below the associated TX-channel will blink with double frequency. The operator can react to this indication by activating the corresponding channel for monitoring (if not yet done) or starting communication.

3.9.3 Selective CALL forced monitoring

If forced monitoring for “Selective CALL” is activated in the configuration of the system, the associated TX-channel is automatically monitored as long as the selective CALL is active. If this

channel is being already monitored, there is no additional action.

3.10 Built in test

3.10.1 Power-up built in test (P-BIT)

Every time the system is powered, an internal self test procedure is started.

While the test is running, the LED above the "TEST" push button is active. The test lasts up to 4 seconds. After the test, the following results are shown:

- No failure detected yellow LED gets off; the system is in normal mode
- Failure detected yellow LED starts

If the internal test routine detected a failure (yellow LED is blinking), the operator has 2 possibilities:

- By pressing the "TEST" button, the failure can be acknowledged. In case at a permanent problem inside the system, it will be detected by the continuous self test routine and indicated again.
- Switching into the slaved or emergency mode by using the "BACK-UP" switch

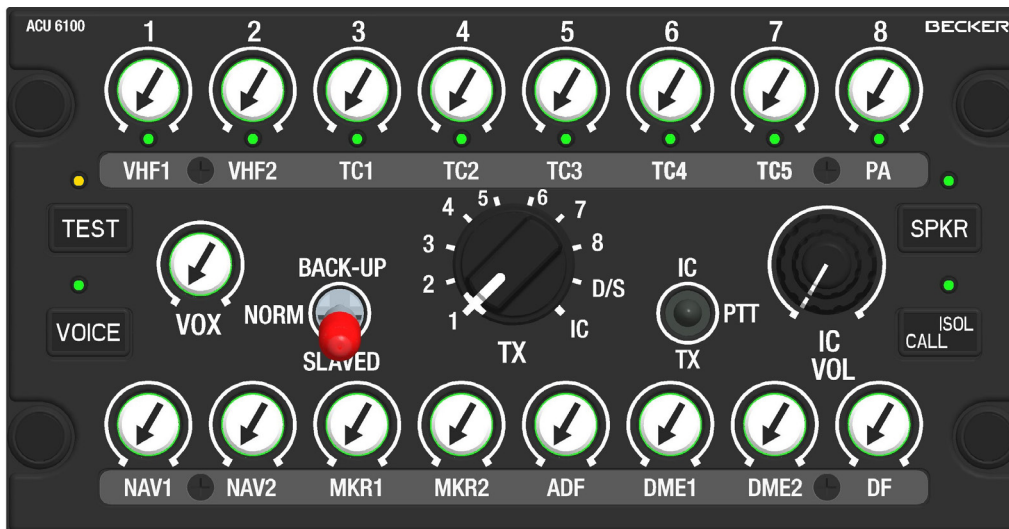

Figure 3-16 Power-up built in test

3.10.2 Continuous built in test (C-BIT)

During normal operation of the system, a permanent background test routine is continuously running. If an error is detected, the "TEST" LED starts to flash. If it is not a fatal error, the operator can acknowledge the failure by pressing the test button.

In case of notable degradation in unit or system performance, the operator can turn to emergency operation, either in "SLAVED" or "BACK-UP" mode.

3.10.3 Initiated built in test (I-BIT)

An initiated built in test can be activated on each ACU at any time by pressing the "TEST" button (except during transmission mode).

3.11 Emergency operation

3.11.1 Slave operation



Figure 3-17 Slave operation

When switching the emergency toggle switch to position "SLAVED" on ACU 1 or ACU 2, the matching headset is disconnected from its audio processing circuits in the Remote Electronic Unit and its mike and phone capsules are directly paralleled to the headset of the remaining ACU.

No further action is possible on the slaved Audio Control Unit.

"SLAVED" mode is a first step of security in the case where one of the control panels appears to be defective or not working.

3.11.2 Back-Up operation

The Audio Control Unit provides a back-up mode. This mode can be activated either by a dedicated switch on the cockpit ACU panels or in an automatic way by the system itself.

3.11.3 Back-Up switch activated

The pilot or copilot has the possibility to activate the back-up mode by switching a special toggle switch (after unlocking by pulling its lever) in position "BACK UP".

In this mode, the microphone and headphone amplifier is powered via an external emergency supply provided by the aircraft.

The following signal routings and functionalities are active in back-up mode:

- Headphone 1 - TX 1 & FIX 1
- Headphone 2 - TX 2 & FIX 2
- Intercom volume level is fixed to 50% CVR 1 and 2 level is fixed to 50%
- No actions on the ACUs are supported

3.11.4 Automatic activation

When the two main power supply busses fail or if a fatal defect occurs within the unit's internal supply, the security logic falls back to Back-Up operation even if the "BACK-UP" switch had not been activated. The signal routings and functionalities are as described in chapter 3.11.3

3.12 Special Version Audio Control Unit ACU6100-X-(XXX0) Intercom /PTT Switch on ACU

This ACU variant ACU6100-X-(XXX0) supports a 2-state up/down IC/TX PTT- tip switch. The upper position "IC" is for activation of a "Hot Mike Mode" that means the mike line is "open" and the signal is forwarded directly to the intercom. The lower position "TX" is used to key the transmitter in transmit mode. The mike selector label "D" has changed into "D/S" because of the new feature Simulcast (= Multi Transmission). This functionality is described in chapter 3.5.7.



Figure 3-18 Special Version Audio Control Unit ACU6100-X-(XXX0) Intercom /PTT Switch on ACU

3.13 Special Version Audio Control Unit ACU6100-X-(X9X) (RX Version)

The Audio Control Unit ACU6100-X-(X9X) (RX Version) is the same as the standard ACU6100-X-(XXX) but no mike selector and no PTT switch is available. It allows control of:

- Monitoring of up to 16 receivers with a capability of individual volume control. The Voice filter functionality is only available on the lower RX row.
- Aircraft intercommunication in VOX mode

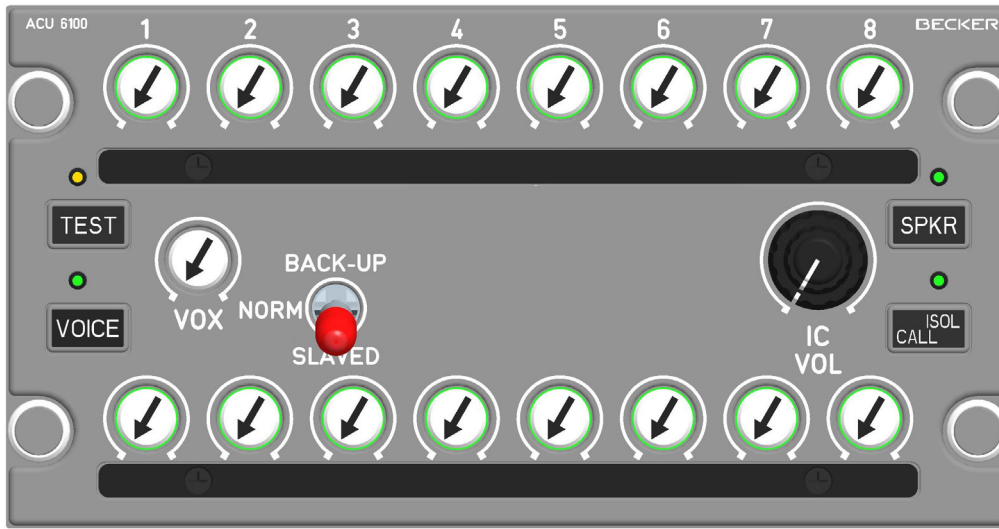

Figure 3-19 Special Version Audio Control Unit ACU6100-X-(X9X) (RX Version)

The function of the operating controls and indicators are the same as the standard Version.

3.14 Selection of Relay Mode

The relay mode is pre-selected by turning the TX-selector rotary switch in position D/S. Two transceivers can be selected by push release the knob for relay operation. The correct selection is indicated by a LED below the corresponding two transceivers. All LED indication will be "OFF" if more or less than two transceivers are selected (not allowed). The channels of radios, allowed for relay operation is predefined during configuration setup. Both selected transceivers will be ready for monitoring the audio. As soon one of the radios received a call automatically the other will be activated for transmit mode.

While relay mode is active the operator can still participating intercommunication with other crew members.

As long the transceivers selected for relay operation does not receive a call signal they can be used for transmit from all the other operators. If one of the transmitters will receive a call signal automatically the relay operation takes over the lead.

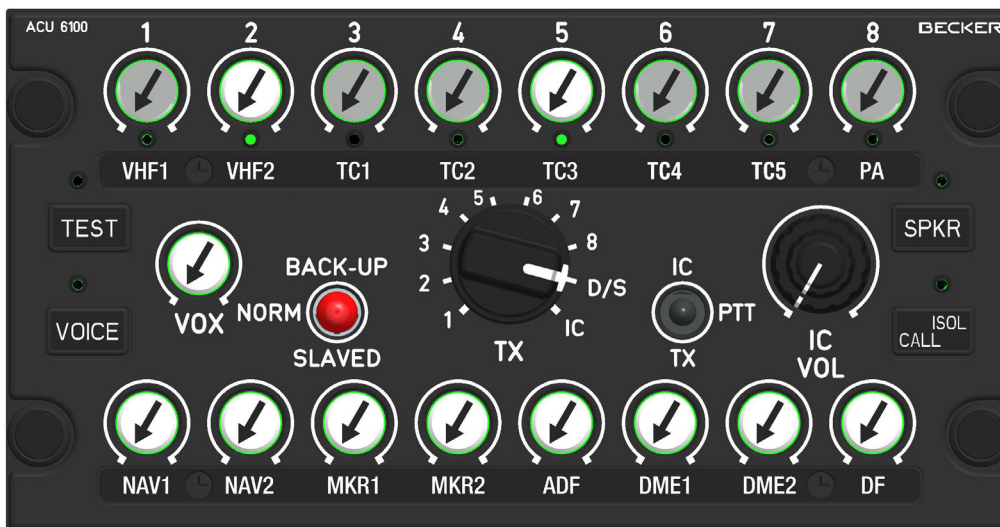

Figure 3-20 Transceiver 2 and 5 are selected for relay operation

3.15 Special Version Audio Control Unit ACU6100-X-(XXX5) Fixed Wing Version

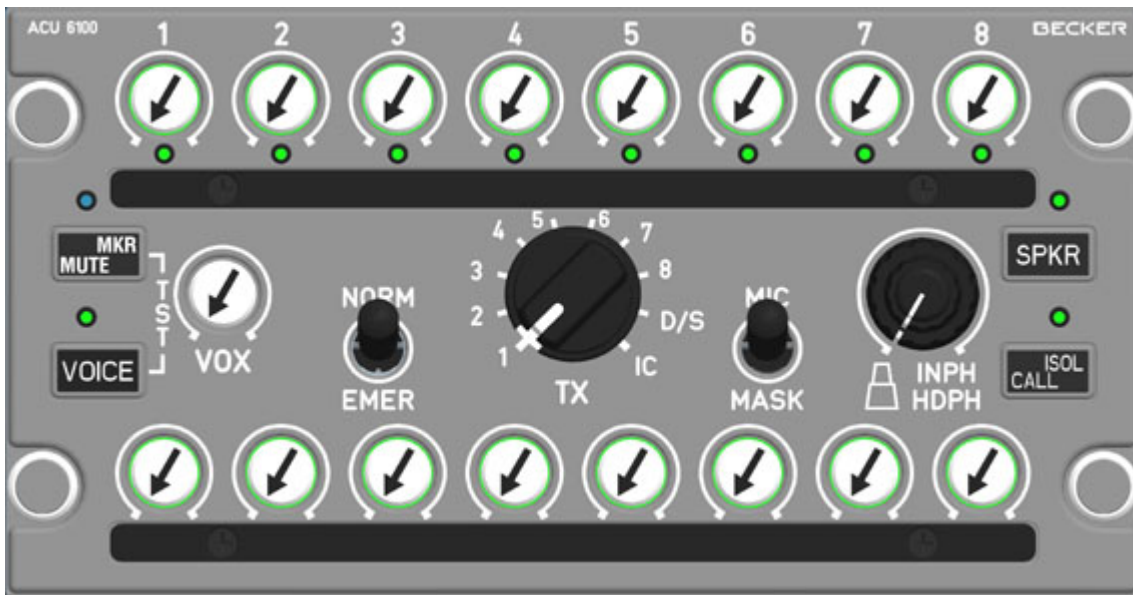

Figure 3-21 Special Version Audio Control Unit ACU6100-X-(XXX5) Fixed Wing Version

The ACU variant ACU6100-X-(XXX5) supports a 2 state switch for “NORM” and “EMER” – mode, and a 2 state switch for “MIC” and “MASK” switch over. Both switches are with lever locking.

- “NORM” system in normal operation
- “EMER” selection activates the Backup mode (refer to the paragraph 3.11.2)
- “MIC” mike operation with headset or hand mike
- “MASK” oxygen mike operation. Switch activates an external relay to switch over between standard mike and oxygen mike operation. By selecting the MASK mike operation the speaker function is automatically activated. By briefly pressing the “SPKR” - button speaker mode can be deactivated.
- Button “MKR/MUTE” activates the Marker receiver mute function (mute time = 30 sec.).
- Test (IBIT) can be activated by briefly pressing the button “MKR/MUTE” and the button “VOICE” at the same time. Details about the test function are described in paragraph 3.10.

Section 4 List of Abbreviations

ACU	Audio Control Unit
dB	Decibel
FIX	Fixed Input
IC	Intercommunication
ISOL/CALL	Isolate / Request Call
LRU	Line replaceable unit
LED	Light Emitting Diode
PA	Public Address
PTT	Push-to-Talk-key
REU	Remote Electronic Unit
RX	Receiver
SPKR	Speaker
TX	Transceiver
VOL	Volume
VOX	Voice Operated Switch

Fault description

Unit type: Serial number:

Aircraft type:

Brief description of the fault:

.....
.....
.....
.....
.....
.....
.....
.....

Should the fault only occur sporadically, please answer the following questions:

The fault occurs after minutes of operation.

The fault occurs under the following environmental conditions:

- low temperature
- high temperature
- high humidity
- vibration

For further questions you may contact the following address:

Becker Avionics GmbH
Product Support
Baden Airpark
Victoria Boulevard B108
77836 Rheinmünster
Phone: +49 7229 305 294
Fax: +49 7229 305 273
e-mail: support@becker-avionics.com